



cendrex

Odd size doors **faster!**



Effective
NOVEMBER 2013:
To provide a more
aesthetic finish, CENDREX
Access Doors will be manufactured
in "WHITE POWDER COAT" primer.



LEED ready

Check out the **revolutionary**
CTA Access Door on page 4



ACCESS DOORS C A T A L O G

TABLE OF CONTENTS

CENDREX AT A GLANCE	3	
GENERAL PURPOSE ACCESS DOORS		
CTA – REVOLUTIONARY, ADJUSTABLE, GENERAL PURPOSE ACCESS DOOR	4-7	
CTR – DOOR WITH HIDDEN FLANGE FOR ALL SURFACE TYPES	8	
AHD – GENERAL PURPOSE DOOR FOR ALL SURFACE TYPES – AHD-GYP	9	
FIRE RATED ACCESS DOORS		
TESTS AND STANDARDS	10	
PFI – FIRE RATED INSULATED DOOR FOR ALL SURFACE TYPES – PFI-GYP	11	
PFU – FIRE RATED INSULATED UPWARD OPENING DOOR FOR CEILINGS ONLY	12	
PFN – FIRE RATED UNINSULATED DOOR FOR WALLS ONLY – PFN-GYP	13	
RECESSED ACCESS DOORS		
AHA – RECESSED DOOR WITHOUT FLANGE – AHA-GYP	14	
SPECIALTY ACCESS DOORS		
LHD – HEAVY DUTY DOOR FOR LARGE OPENINGS – LHD-GYP / LHD-180	15	
PAL – INSULATED ALUMINUM DOOR FOR ALL SURFACE TYPES	16	
DRD – DRAFT STOP DOOR FOR ATTIC APPLICATION	17	
SFM – SURFACE MOUNTED DOOR	18	
RPL – REMOVABLE PLASTIC DOOR	18	
CABINETS / VALVE BOXES		
BTA – CABINET / VALVE BOX WITH HIDDEN FLANGE	19	
BTV – CABINET / VALVE BOX WITH WINDOW AND HIDDEN FLANGE	19	
SECURITY ACCESS DOORS		
MDS – MEDIUM SECURITY DOOR FOR ALL SURFACE TYPES	20	
PHS – HIGH SECURITY DOOR FOR ALL SURFACE TYPES	21	
FLOOR HATCHES (FLOOR ACCESS DOORS)		
PPA – FLUSH ALUMINUM FLOOR HATCHES	22	
– PPA-RE	22	
ROOF HATCHES		
TRH – ROOF HATCHES	23	
ODD SIZE DOORS		
Non-standard size access doors manufactured in 5 business days	24	
CUSTOM DOORS		
Access doors for your special applications manufactured in 10 business days	25	
OPTIONS AND ACCESSORIES		26-29
LEED ready		
CENDREX LEED ready Program developed by LEED® certification specialists	30	
CENDREX Access Doors: Sustainable products that can help with your LEED® certification	31	
THE CENDREX ADVANTAGE, CONTACTS AND WAREHOUSES		32



Founded in 1985 and servicing a multitude of distributors located mainly in North America, CENDREX designs and manufactures a full range of quality Access Doors, Roof and Floor Hatches.

Its KAÏZEN philosophy of continuous improvement has enabled CENDREX to become the most flexible and accommodating company in its field. As a result, the company offers unparalleled products and services to better fulfill the needs of its clients within the construction industry.

Here is a quick view of what CENDREX has to offer:

CTA: Revolutionary, adjustable, general purpose access door - See pages 4-7
REDUCE installation time by 90% - ADJUSTABLE in size - AESTHETIC APPEARANCE

CTR: Contour Hidden Flange Access Door CENDREX has engineered the unique and exclusive CTR Contour Hidden Flange Door. Easy installation, no mudding, taping or apparent flange, make the CTR the most aesthetically pleasing access door available on the market. See page 8.



WHITE DOORS To provide a more aesthetic finish, CENDREX Access Doors are manufactured in "WHITE POWDER COAT" primer. No need to repaint.

ODD SIZE DOORS in 5 days Get your odd size access doors manufactured in 5 business days. CENDREX is the industry's leader in the fabrication of odd sizes.

CUSTOM DOORS in 10 days Get your custom access doors manufactured in 10 business days. Shop drawings are provided for all custom doors.

LOCAL representatives CENDREX has local representatives throughout North America and beyond.

EXTENSIVE distribution network

- **LOCAL DISTRIBUTORS/PARTNERS** CENDREX sells exclusively through its distribution network.
- **REGIONAL WAREHOUSES** Located in California, Colorado, Florida, Illinois, Pennsylvania, Texas and Canada.

LEED ready CENDREX access products contribute directly to obtaining points for LEED® certification. All LEED® documents are developed in association with the foremost LEED® certification specialists, YRG in the U.S.A. and Vertima in Canada, to provide you with information you can trust.

GREEN beyond LEED® CENDREX is incorporating sustainability strategies at all levels through an on-going commitment to reduce waste and increase efficiency.

Visit our website for complete up-to-date information: www.cendrex.com

Who said **INNOVATION** was impossible
in the access door business?

The revolutionary CTA adjustable door



DEMO VIDEO



- 1 MINUTE -

➤ **REDUCE** installation time by 90%

➤ **ADJUSTABLE:**

Adjusts to 1.5" in width and height to fit various opening sizes.

➤ **AESTHETIC:**

Magnetic latch and hidden flange for a concealed appearance.

REDUCE installation time by 90%

- No tools required if cut-out opening already exists
- No additional installation components required
- No need to box in (frame) the wall or the ceiling
- Virtually anyone can install this product

QUICK INSTALLATION IN 6 EASY STEPS



 Always install the security cables

50 DOOR INSTALLATION SCENARIO

CONVENTIONAL DOOR DESIGN		CENDREX REVOLUTIONARY CTA	
Cost of doors: 50 doors at \$ 30	\$ 1500	Cost of doors: 50 doors at \$ 30	\$ 1500
Installation cost (including framing): 50 doors x 25 min = 1250 min ≈ 20 hours 20 hours x \$ 50/hour	\$ 1000	Installation cost (no framing required): 50 doors x 2 min = 100 min ≈ 2 hours 2 hours x \$ 50/hour	\$ 100
Total cost installed:	\$ 2500	Total cost installed:	\$ 1600
		SAVINGS FOR 1 SINGLE JOB: 35 % OR	\$ 900
Materials required: Power tools, wood/steel framing, and expertise		Materials required: None	

Note: Cost based on existing, prepared wall openings

ADJUSTABLE: Adjusts up to 1.5" in width and height to fit various opening sizes.

5 DOOR DIMENSIONS TO COVER A VARIETY OF WALL OPENING SIZES

PRODUCT CODE FOR OPENINGS (inches)

- CTA 6 x 7.5** 6 x 6 up to 7.5 x 7.5
- CTA 8 x 9.5** 8 x 8 up to 9.5 x 9.5
- CTA 10 x 11.5** 10 x 10 up to 11.5 x 11.5
- CTA 12 x 13.5** 12 x 12 up to 13.5 x 13.5
- CTA 14 x 15.5** 14 x 14 up to 15.5 x 15.5

Over 15.5" x 15.5": use the CTR access door to keep the same aesthetic look.

	FRAMES PER SKU	min	Inch			max
		A	B	C	D	E
6X7.5		6"	6.375"	6.75"	7.125"	7.5
8X9.5		8"	8.375"	8.75"	9.125"	9.5
10X11.5		10"	10.375"	10.75"	11.125"	11.5
12X13.5		12"	12.375"	12.75"	13.125"	13.5
14X15.5		14"	14.375"	14.75"	15.125"	15.5

ADJUSTABLE FRAME: 3/8" INCREMENTS

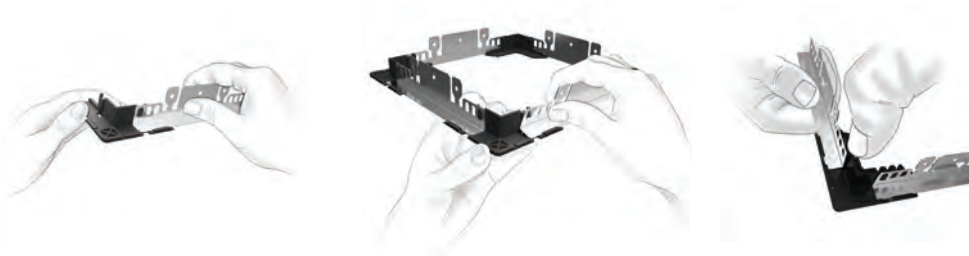

ADJUSTABLE FRAME		
A	MIN	
B	MIN + 3/8	
C	MIN + 3/4	
D	MIN + 1 1/8	
E	MIN + 1 1/2	

ADJUSTABLE TO DIFFERENT OPENING SIZES

For square or rectangular openings

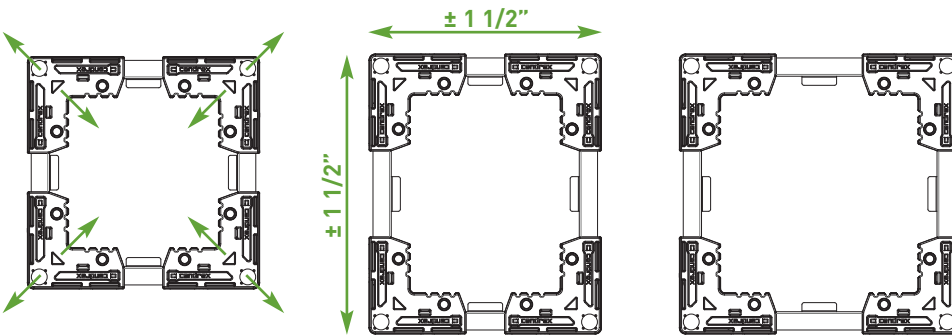

LATCH:

Door magnetically secured in place
(4 magnets, 1 per corner)

LOCK OPTION:

Screwdriver operated cam latch



CTA-35

FITS 3/8" TO 1" THICK WALLS / CEILINGS

Fasten with screws if wall / ceiling is more than 1" thick

CTA

ADJUSTABLE GENERAL PURPOSE ACCESS DOOR

Unlike most existing access doors, the **CTA** door is adjustable to the size of the opening; offering a flush-mounted, metal panel that is durable and versatile. Installing the door is quick and easy and requires minimal tools. The **CTA** door is also aesthetically superior and it is offered in two models, one with a screwdriver lock and one without.

DESCRIPTION

- Material:** Door panel: 20 gauge cold rolled steel
Frame: 24 gauge galvanized steel frame with notched knock-over tabs
Corners: polymer
- Lock / latch:** 4 magnets, 1 per corner
- Cables:** 2 security cables
- Finish:** high quality white powder coat primer
- Packaging:** individually wrapped, 1 per box pre assembled

CTA-35 ACCESS DOOR

OPTION

Lock / latch: screwdriver operated cam latch

LEED ready: This product contributes to LEED® credits.
Visit www.cendrex.com for more information.



Front view

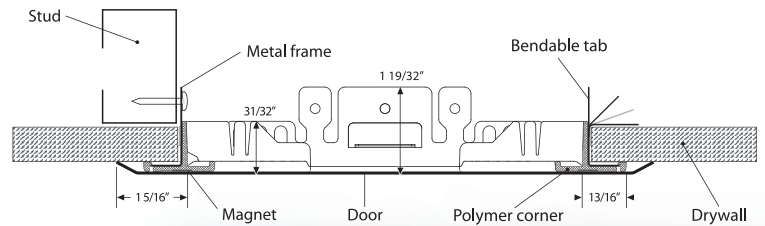

Lock option

CTA-35

Screwdriver operated cam latch

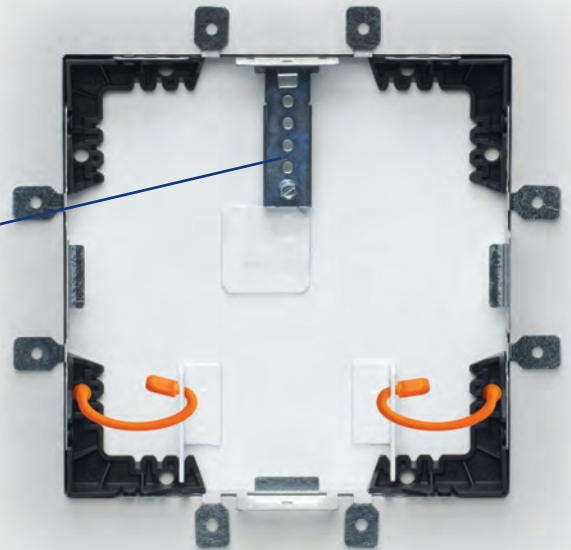

Rear view

Table of standard sizes

PRODUCT CODE	FOR OPENINGS - W x H		SHIPPING WEIGHT			
	INCHES	(MM)	INCHES	(MM)	LBS	KG
CTA 6 x 7.5	6 x 6	(152 x 152)	up to 7.5 x 7.5	(191 x 191)	2.5	1.1
CTA 8 x 9.5	8 x 8	(203 x 203)	up to 9.5 x 9.5	(241 x 241)	2.75	1.2
CTA 10 x 11.5	10 x 10	(254 x 254)	up to 11.5 x 11.5	(292 x 292)	3.25	1.5
CTA 12 x 13.5	12 x 12	(304 x 304)	up to 13.5 x 13.5	(343 x 343)	3.75	1.7
CTA 14 x 15.5	14 x 14	(355 x 355)	up to 15.5 x 15.5	(394 x 394)	4.25	1.9

Over 15.5" x 15.5": use the CTR access door

Always install the security cables



The **CTR** is the **newest generation of all purpose access doors**. Easy to install, it will blend into all non-rated surfaces better than any other door. Its special European type hinge allows the door, with its beveled edges, to close over the flange thus avoiding the additional labor to mud or plaster over the flange. The CTR features a truly cohesive appearance due to its well-integrated design of concealing the space between the panel and the flange.



**A LABOR SAVING
alternative to doors
with DRYWALL FLANGES**

“No need to mud or plaster”

DESCRIPTION

- Material:** 16 gauge cold rolled steel
- Hinge:** concealed, exclusive hinge design
- Lock / latch:** screwdriver operated cam latch
- Finish:** high quality white powder coat primer
- Packaging:** individually wrapped, 1 per box

POPULAR OPTIONS

[see p. 26-29 for complete list of options]

- Material:** stainless steel 304 #4 (brushed finish)
- Lock / latch:** key operated cylinder cam latch, hex head cam latch, pinned hex head cam latch, handle operated cam latch, mortise preparation for cylinder. (cylinder optional)
- Gasketing:** neoprene gasket

RMD ACCESS DOOR

Removable access door with hidden flange is ideal for confined spaces where access is limited or where a pivoting door panel cannot be used due to an obstruction.

LEED ready: This product contributes to LEED® credits.
Visit www.cendrex.com for more information.

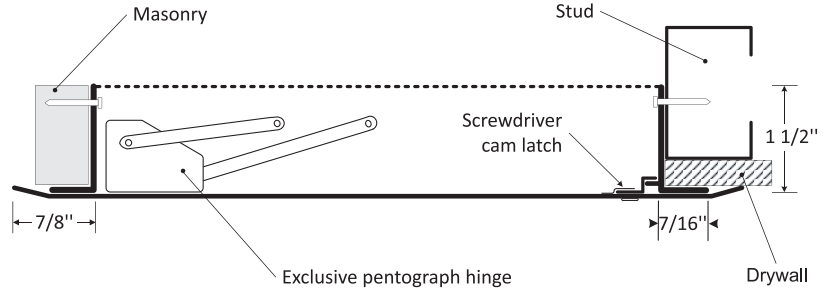

Table of standard sizes

[other sizes available upon request]

DOOR SIZE - W x H INCHES (MM)	NUMBER OF LOCKS	SHIPPING WEIGHT	
		LBS	KG
8 1/4 x 8 1/4 (210 x 210)	1	3	1.4
8 1/4 x 12 (210 x 304)	1	4	1.8
10 x 10 (254 x 254)	1	4	1.8
12 x 12 (304 x 304)	1	6	2.7
14 x 14 (355 x 355)	1	7	3.2
12 x 18 (304 x 457)	1	8	3.6
16 x 16 (406 x 406)	1	9	4.1
18 x 18 (457 x 457)	3	10	4.5
18 x 24 (457 x 609)	4	13	5.9
20 x 20 (508 x 508)	3	13	5.9
22 x 22 (558 x 558)	3	15	6.8
22 x 30 (558 x 762)	5	17	7.7
22 x 36 (558 x 914)	5	19	8.6
24 x 24 (609 x 609)	4	17	7.7
24 x 30 (609 x 762)	5	19	8.6
24 x 36 (609 x 914)	5	24	10.9

Rough wall opening = door size + 1/4" or + 6mm

CTR HIDDEN FLANGE CONCEALED APPEARANCE

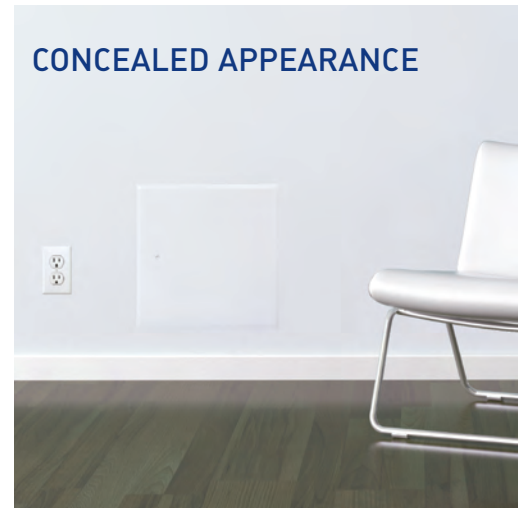

**Your odd sizes:
Made in 5 days**

The **AHD** is designed for a **quick and easy installation** on non-rated vertical and horizontal surfaces made of drywall or any other type of material. Its rounded mitered corners, concealed pin hinge and 3/8" return all around the door make it the sturdiest door on the market. The AHD prevents sagging, as compared to flat door panels, and requires fewer locks.



DESCRIPTION

- Material:** 16 gauge cold rolled steel
- Hinge:** hidden pin hinge
continuous piano type on doors over 24" (height or width)
- Lock / latch:** screwdriver operated cam latch
- Finish:** high quality white powder coat primer
- Packaging:** individually wrapped, 1 per box

POPULAR OPTIONS

[see p. 26-29 for complete list of options]

- Material:** stainless steel 304 #4 (brushed finish)
- Lock / latch:** key operated cylinder cam latch, hex head cam latch, pinned hex head cam latch, handle operated cam latch, mortise preparation for cylinder. (cylinder optional)
- Gasketing:** neoprene gasket

LEED ready: This product contributes to LEED® credits.
Visit www.cendrex.com for more information.

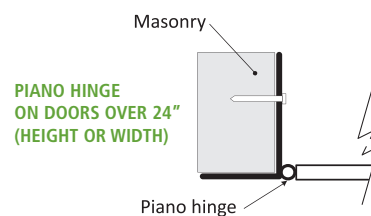
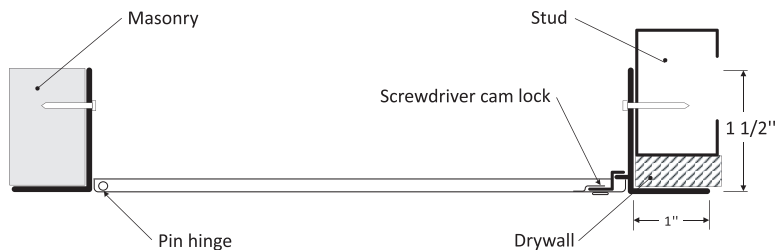

Table of standard sizes

[other sizes available upon request]

PRODUCT CODE	DOOR SIZE W x H inches (MM)	NUMBER OF LOCKS	SHIPPING WEIGHT	
			LBS	KG
AHD	6 x 6 (152 x 152)	1	2	0.9
AHD/GYP/PLY	8 x 8 (203 x 203)	1	3	1.4
AHD	8 x 12 (203 x 304)	1	4	1.8
AHD/GYP/PLY	10 x 10 (254 x 254)	1	4	1.8
AHD/GYP/PLY	12 x 12 (304 x 304)	1	5	2.3
AHD	12 x 16 (304 x 406)	1	6	2.8
AHD	12 x 18 (304 x 457)	1	7	3.2
AHD	12 x 24 (304 x 609)	1	8	3.6
AHD/GYP/PLY	14 x 14 (356 x 356)	1	7	3.2
AHD/GYP/PLY	16 x 16 (406 x 406)	1	8	3.6
AHD/GYP/PLY	18 x 18 (457 x 457)	1	10	4.5
AHD	18 x 24 (457 x 609)	1	13	5.9
AHD	20 x 20 (508 x 508)	1	11	5
AHD	22 x 22 (558 x 558)	1	13	5.9
* AHD	22 x 30 (558 x 762)	2	17	7.7
* AHD	22 x 36 (558 x 914)	2	19	8.6
* AHD/GYP/PLY	24 x 24 (609 x 609)	1	15	6.8
* AHD	24 x 30 (609 x 762)	2	20	9.1
* AHD/GYP/PLY	24 x 36 (609 x 914)	2	22	10
* AHD	24 x 48 (609 x 1219)	2	28	12.7
* AHD	30 x 30 (762 x 762)	4	23	10.4
* AHD	36 x 36 (914 x 914)	4	31	14.1

The LHD model is recommended for over 1296 sq. inches - See page 15

Rough wall opening = door size + 1/4" or + 6mm

*Piano hinge on doors over 24 inches (height or width)

Your odd sizes:
Made in 5 days



GENERAL PURPOSE DOOR WITH DRYWALL FLANGE



CENDREX FIRE RATED ACCESS DOORS: TESTS AND STANDARDS

CENDREX fire rated access doors, PFN, PFI and PFU, have been tested by Intertek – Warnock Hersey and are currently listed under the following standards: UBC 7-2 (1997), UL 10B (1997), UL 10B (2009), NFPA 252 (2003), NFPA 252 (2008), NFPA 252 (2012), CAN/ULC S104 (R1985), CAN/ULC S104 (2010), ASTM E119 (2012), CAN/ULC S101 (2007).

A Warnock Hersey (WH) Mark with both "us" and "c" identifiers signifies that the product bearing the mark complies with both U.S. and Canadian product safety standards.



WHAT DOES A CERTIFICATION MARK TELL ME?

Certification marks such as WH, CSA, and UL signify that the product has been tested to, and found to comply with, national standards by a qualified, independent testing laboratory. The presence of a certification mark also means the product is listed in the directory of the laboratory that verified the product's compliance and is part of an on-going follow-up program that ensures the product's continued compliance during manufacturing.

IS THERE A DIFFERENCE BETWEEN THE WH, CSA, AND UL MARKS?

No. Each mark demonstrates that the product has met the minimum requirements of widely accepted standards as determined through independent testing.

IS PRODUCT CERTIFICATION MANDATORY?

Within North America product testing is mandatory before market entry; however, the choice of testing partners is up to the manufacturer.

- The WH Mark from Intertek is recognized by all Authorities Having Jurisdiction (AHJs). This includes building code officials, fire marshals, and inspectors across North America;
- Intertek testing laboratories are recognized by the American National Standards Institute (ANSI) as an Accredited Certification Body;
- Intertek is accredited by the Standards Council of Canada as an accredited Testing Organization and Certification Body;
- In North America Intertek is recognized by the International Codes Council Evaluation Service (ICC-ES);
- The WH Mark is a recognized as equivalent to the CSA and UL marks for Canada and the U.S. for fire rated access doors.

AREN'T MANUFACTURERS REQUIRED TO USE CSA OR UL FOR THEIR TESTING? ISN'T THIS MANDATED BY THE STANDARDS THEMSELVES?

The simple answer to both questions is "no." In fact, this misconception has misled many manufacturers to believe that they don't have a choice in their third-party testing partner. To satisfy the prerequisite of having products tested by an independent organization, the true legal requirement is that the testing laboratory must be an ANSI accredited Certification Body, an OSHA-recognized NRTL (Nationally Recognized Testing Laboratory) or an SCC accredited Testing Organization and Certification Body. Intertek satisfies all of the above prerequisites and is recognized worldwide as a competent testing, inspection and certification organization. The WH Mark serves as proof of product compliance with national standards.

WHO SETS THE STANDARDS?

The standards themselves are developed through a consensus process that takes into account the viewpoints of manufacturers, the insurance industry, private organizations and the general public. The standards are then sponsored by non-government organizations such as the American National Standards Institute (ANSI), ASTM and CSA.

• The International Code Council (ICC):

The International Code Council (ICC) is a membership association dedicated to building safety and fire prevention. ICC develops the codes and standards used to construct residential and commercial buildings, including homes and schools. www.iccsage.org

• American National Standards Institute (ANSI):

The American National Standards Institute (ANSI) oversees the creation, promulgation and use of thousands of norms and guidelines. ANSI is also actively engaged in accrediting programs that assess conformance to standards. www.ansi.org

• National Fire Protection Association (NFPA):

NFPA develops, publishes, and disseminates more than 300 consensus codes and standards intended to minimize the possibility and effects of fire and other risks. Virtually every building, process, service, design, and installation in society today is affected by NFPA documents. www.nfpa.org

• Canadian Standards Association (CSA) - www.csa.ca

• The International Accreditation Service (IAS) - www.iasonline.org

• Nationally Recognized Testing Laboratory (NRTL) - www.osha.gov/dts/otpc/nrtl

• ASTM International - www.astm.org

• Underwriters Laboratories (UL) - www.ul.com

• The Standards Council of Canada (SCC) - www.scc.ca

The PFI is insulated with 2" thick mineral wool and can be used on fire rated walls and ceilings. It comes with a 1" flange for an easy flush installation on any type of surface. As per UL and NFPA 80 standards, once the installation is complete and the provided springs are hooked to the back of the panel, the door will be self closing and self locking. The largest fire rated PFI doors available for vertical and horizontal installations are respectively: (48" x 48" or 2304 sq. in.) and (24" x 36" or 864 sq. in.).



PFI-GYP
FIRE RATED INSULATED DOOR WITH DRYWALL FLANGE



Tool key



Ring key



SUPPORT BRACKET required for ceiling installation

DESCRIPTION

FIRE RATING: For installation in vertical wall assemblies:
CERTIFIED TO STANDARDS: UBC 7-2 (1997), UL 10B (1997), UL 10B (2009), NFPA 252 (2003), NFPA 252 (2008), NFPA 252 (2012), CAN/ULC S104 (R1985), CAN/ULC S104 (2010).
RATING ACHIEVED: 3 hours, neutral/negative pressure.
MAXIMUM SIZE: 48" wide x 48" high (1219 mm x 1219 mm).
Maximum area of 2304 in².
Tolerance on height and width limitation is ± 3" (76 mm) as long as the area does not exceed 2304 in².
TEMPERATURE RISE: 250°F (121°C) after 30 min.
450°F (232°C) after 60 min.

FIRE RATING: For installation in horizontal ceiling assemblies:
CERTIFIED TO STANDARDS: ASTM E119 (2012), CAN/ULC S101 (2007).
RATING ACHIEVED: 3 hours in non-combustible construction.
1 hour in combustible construction.
MAXIMUM SIZE: 24" x 36" (hinges & latch on 36" long sides) (610 mm x 914 mm).
Tolerances on dimension limitations are ± 3" (76 mm) as long as the area does not exceed 864 in².
TEMPERATURE RISE: Not applicable.

- Material:** 16 gauge cold rolled steel frame and 20 gauge galvalneal steel door
- Insulation:** mineral wool
- Hinge:** continuous piano hinge
- Lock / latch:** self latching tool-key operated slam latch and/or ring operated slam latch, both included
- Inside panel release:** standard on all doors over 12" x 12"
- Automatic panel closer:** standard on all doors
- Finish:** high quality white powder coat primer
- Packaging:** individually wrapped, 1 per box

POPULAR OPTIONS [see p. 26-29 for complete list of options]

- Material:** stainless steel #4 (brushed finish)
- Lock / latch:** handle operated slam latch, mortise preparation for cylinder (cylinder optional), hex head slam latch, mortise deadbolt lock
- Masonry anchor:** available on all sizes

PFI-HS SECURITY for high security PFI-HS: optional 16 gauge cold rolled steel frame and 14 gauge galvalneal steel door

LEED ready: This product contributes to LEED® credits.

Table of standard sizes

[other sizes available upon request]

DOOR SIZE - W x H INCHES (MM)	NUMBER OF LOCKS	SHIPPING WEIGHT	
		LBS	KG
8 x 8 (203 x 203)	1	7	3.2
10 x 10 (254 x 254)	1	8	3.6
12 x 12 (304 x 304)	1	10	4.5
14 x 14 (355 x 355)	1	12	5.4
16 x 16 (406 x 406)	1	14	6.4
18 x 18 (457 x 457)	1	17	7.7
22 x 22 (558 x 558)	1	20	9.1
22 x 30 (558 x 762)	1	30	13.6
22 x 36 (558 x 914)	2	34	15.5
24 x 24 (609 x 609)	1	28	12.7
24 x 36 (609 x 914)	2	36	16.4
* 24 x 48 (609 x 1219)	2	48	21.8
* 30 x 30 (762 x 762)	1	40	18.1
* 32 x 32 (812 x 812)	2	43	19.5
* 36 x 36 (914 x 914)	2	50	22.7
* 48 x 48 (1219 x 1219)	2	83	37.7

Rough wall opening = door size + 1/4" or + 6mm

*Not available for ceiling rating with temperature rise (max. 24"X36")

**Your odd sizes:
Made in 5 days**

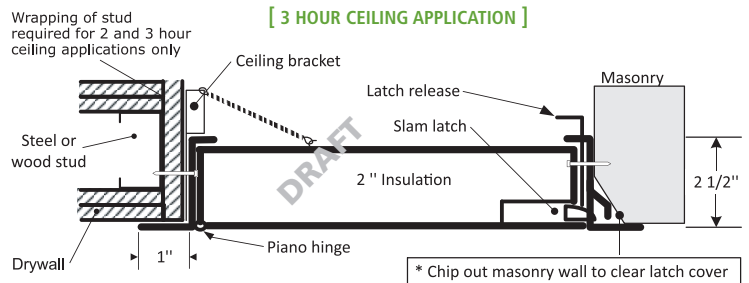

* The latch release allows the opening of the door from inside.

Authorities Having Jurisdiction (AHJ) should be consulted in all cases as to the particular requirements covering the installation and use of fire rated access doors.

The PFU is designed to be installed on fire rated ceilings only. It can easily replace spring loaded models like the PFI. The door panel, which does not exceed 89 degrees of upward opening, falls back by law of gravity into its locked position as required by fire certification standards. Holding the door open while climbing through it becomes much easier with no springs to deal with. The largest fire rated PFU available is: (24" x 36" or 864 sq. in.).



DESCRIPTION

FIRE RATING: For horizontal ceiling assemblies only: CERTIFIED TO STANDARDS: ASTM E119 (2012), CAN/ULC S101 (2007).
RATING ACHIEVED: 3 hours in non-combustible construction. 1 hour in combustible construction.
MAXIMUM SIZE: 24" x 36"
 (hinges & latch on 36" long sides) (610 mm x 914 mm).
 Tolerances on dimension limitations are $\pm 3"$ (76 mm) as long as the area does not exceed 864 in².
TEMPERATURE RISE: Not applicable.

- Material:** 16 gauge cold rolled steel frame and 20 gauge galvalneal steel door
- Insulation:** mineral wool
- Hinge:** continuous piano hinge allows opening to 89°
- Lock / latch:** self latching ring operated slam latch inside and a hex head slam latch outside
- Finish:** high quality white powder coat primer
- Packaging :** individually wrapped, 1 per box

POPULAR OPTIONS [see p. 26-29 for complete list of options]

Material : stainless steel #4 (brushed finish)

LEED ready: This product contributes to LEED® credits. Visit www.cendrex.com for more information.



Wrapping of stud required for 2 and 3 hour ceiling applications only

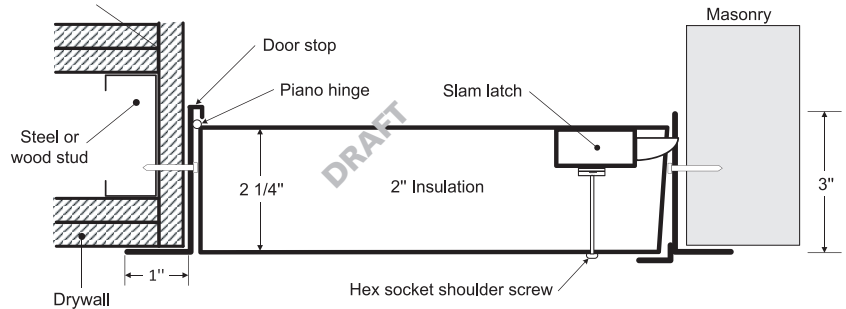

[3 HOUR CEILING APPLICATION]

Authorities Having Jurisdiction (AHJ) should be consulted in all cases as to the particular requirements covering the installation and use of fire rated access doors.

[1 HOUR CEILING APPLICATION]

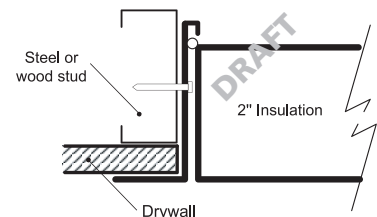

Table of standard sizes

[other sizes available upon request]

DOOR SIZE - W x H INCHES (MM)	NUMBER OF LOCKS	SHIPPING WEIGHT	
		LBS	KG
22 x 30 (558 x 762)	1	30	13.6
22 x 36 (558 x 914)	2	37	16.8
24 x 24 (609 x 609)	1	29	13.2

(Clear opening with door opened = W - 3 1/2")

Rough wall opening = door size + 1/4" or + 6mm

**Your odd sizes:
Made in 5 days**

The PFN is **not insulated** and can **only be used on fire rated walls**. It comes with a 1" flange for an easy flush installation on any type of surface material. As per **UL** and NFPA 80 standards, once the installation is complete and the provided springs installed, this door will be self closing and self locking. It should not be used in situations where protection against temperature elevation is required. The largest fire rated PFN door available is: (36" x 36" or 1296 sq. in.).



DESCRIPTION

FIRE RATING: For vertical wall assemblies only:
CERTIFIED TO STANDARDS: UBC 7-2 (1997), UL 10B (1997), UL 10B (2009), NFPA 252 (2003), NFPA 252 (2008), NFPA 252 (2012), CAN/ULC S104 (R1985), CAN/ULC S104 (2010).
RATING ACHIEVED: 1-1/2 hours, neutral/negative pressure.
MAXIMUM SIZE: 36" wide x 36" high (914 mm x 914 mm). Maximum area of 1296 in². Tolerance on height and width limitation is ± 3" (76 mm) as long as the area does not exceed 1296 in².
TEMPERATURE RISE: No rating achieved.
Material: 16 gauge cold rolled steel
Hinge: continuous piano hinge
Lock / latch: self latching tool-key operated latch and/or ring operated latch, both included
Inside panel release: standard on all doors over 12" x 12"
Automatic panel closer: standard on all doors
Finish: high quality white powder coat primer
Packaging: individually wrapped, 1 per box

POPULAR OPTIONS [see p. 26-29 for complete list of options]

Material: stainless steel #4 (brushed finish),
Lock / latch: key operated cylinder cam latch, handle operated slam latch, mortise preparation for cylinder (cylinder optional), hex head slam latch, mortise deadbolt lock
Masonry anchor: available on all sizes

LEED ready: This product contributes to LEED® credits. Visit www.cendrex.com for more information.

Table of standard sizes [other sizes available upon request]

DOOR SIZE - W x H INCHES (MM)	NUMBER OF LOCKS	SHIPPING WEIGHT	
		LBS	KG
8 x 8 (203 x 203)	1	5	2.3
10 x 10 (254 x 254)	1	7	3.2
12 x 12 (304 x 304)	1	8	3.6
14 x 14 (355 x 355)	1	10	4.5
16 x 16 (406 x 406)	1	12	5.5
18 x 18 (457 x 457)	1	14	6.4
22 x 22 (558 x 558)	1	18	8.2
22 x 30 (558 x 762)	1	22	10.0
22 x 36 (558 x 914)	2	27	12.2
24 x 24 (609 x 609)	1	22	10.0
24 x 36 (609 x 914)	2	29	13.2
30 x 30 (762 x 762)	1	30	13.6
32 x 32 (812 x 812)	2	33	15
36 x 36 (914 x 914)	2	39	17.7

Rough wall opening = door size + 1/4" or + 6mm

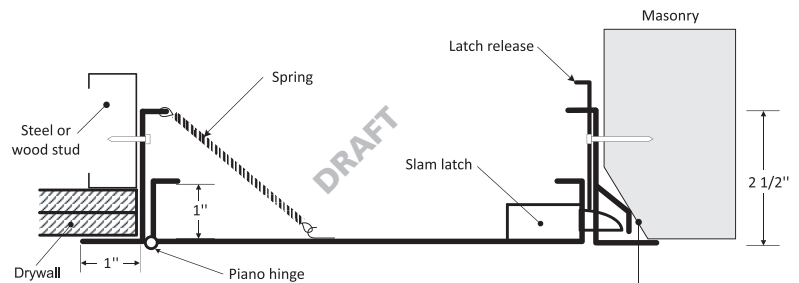

Authorities Having Jurisdiction (AHJ) should be consulted in all cases as to the particular requirements covering the installation and use of fire rated access doors.

PFN-GYP



FIRE RATED UNINSULATED DOOR WITH DRYWALL FLANGE

**Your odd sizes:
Made in 5 days**

The **AHA's** standard 5/8" **recessed panel** will accept ceramic tiles, drywall panels, acoustical tiles or other materials to match the surface finish on which it is installed. It is also available in different recesses of up to 1 1/2" to accommodate multi layers of drywall.



DESCRIPTION

- Material:** 16 gauge cold rolled steel
- Hinge:** continuous piano hinge
- Lock / latch:** Allen hex head cam latch
- Finish:** high quality white powder coat primer
- Packaging:** individually wrapped, 1 per box
- Recess:** 5/8" standard

POPULAR OPTIONS

[see p. 26-29 for complete list of options]

- Material:** stainless steel 304 #4 (brushed finish)
- Latch:** key operated cylinder cam latch
- Recess:** 1/2" to 3/4" (standard 2" frame)
13/16" to 1 1/2" (special 3" frame)

LEED ready: This product contributes to LEED® credits.
Visit www.cendrex.com for more information.



AHA-GYP

**RECESSED DOOR
WITH DRYWALL FLANGE**

Table of standard sizes

[other sizes available upon request]

DOOR SIZE - W x H INCHES (MM)	NUMBER OF LOCKS	SHIPPING WEIGHT	
		LBS	KG
8 x 8 (203 x 203)	1	3	1.4
12 x 12 (304 x 304)	1	5	2.3
16 x 16 (406 x 406)	1	9	4.1
18 x 18 (457 x 457)	1	11	5
24 x 24 (609 x 609)	1	16	7.3

Rough wall opening = door size + 1/4" or + 6mm

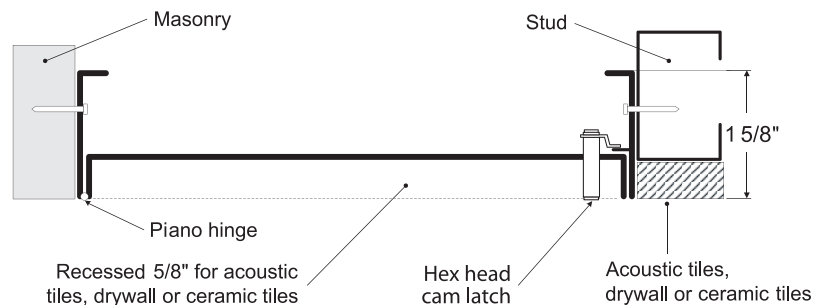

**Your odd sizes:
Made in 5 days**

LHD

HEAVY DUTY ACCESS DOOR FOR LARGE OPENINGS

The **LHD** door with its **2 1/2" deep frame** and heavy duty design is ideal for openings larger than the AHD can accommodate. It is also available in a double leaf version.



DESCRIPTION

- Material:** 16 gauge cold rolled steel
- Hinge:** continuous piano hinge
- Lock / latch:** self latching tool-key operated slam latch and/or ring operated slam latch, both included
- Inside panel release:** standard on all doors over 12" x 12"
- Finish:** high quality white powder coat primer
- Packaging :** individually wrapped, 1 per box

POPULAR OPTIONS

[see p. 26-29 for complete list of options]

- Material:** stainless steel 304 #4 (brushed finish)
- Lock / latch:** key operated cylinder cam latch, handle operated slam latch, mortise preparation for cylinder (cylinder optional), mortise deadbolt lock
- Design:** double leaf

LEED ready: This product contributes to LEED® credits. Visit www.cendrex.com for more information.

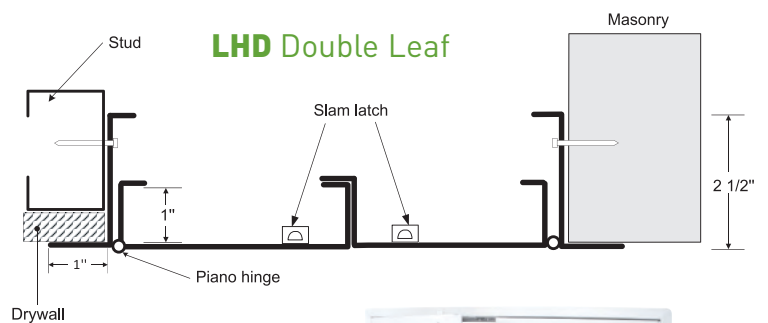
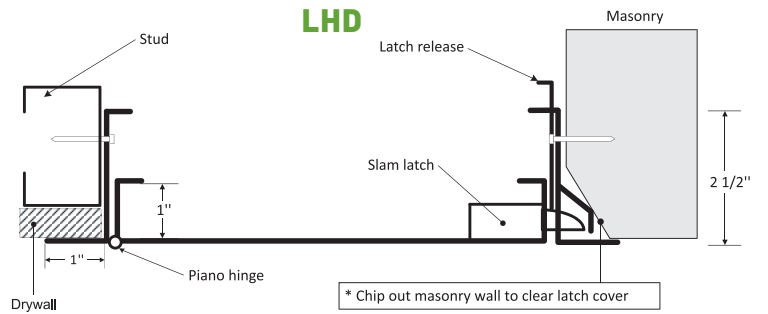

LHD-GYP



**HEAVY DUTY
DOOR FOR LARGE
OPENINGS
WITH DRYWALL
FLANGE**

Table of standard sizes

[any sizes available upon request]

Any size made in record time

Rough wall opening = door size + 1/4" or + 6mm

**Your odd sizes:
Made in 5 days**

LHD-180

DOUBLE LEAF DOOR



The **PAL door** with **1" fiberglass wool insulation** and **neoprene gasket** is ideal to reduce sound and air transfers between partitions. The robust all aluminum construction allows for its use in large wall or ceiling openings and where corrosion and moisture are a concern.



DESCRIPTION

- Material:** 0.064" aluminum
- Insulation:** 1" fiberglass wool
- Hinge:** aluminum continuous piano type
- Gasketing:** neoprene all around perimeter
- Lock / latch:** cylinder lock and key
- Finish:** high quality white powder coat primer
- Packaging:** individually wrapped, 1 per box

POPULAR OPTIONS [see p. 26-29 for complete list of options]

- Material:** stainless steel 304 #4 (brushed finish)
- Lock / latch:** screwdriver operated cylinder cam latch, mortise slam latch preparation (cylinder optional), handle operated cam latch

LEED ready: This product contributes to LEED® credits. Visit www.cendrex.com for more information.

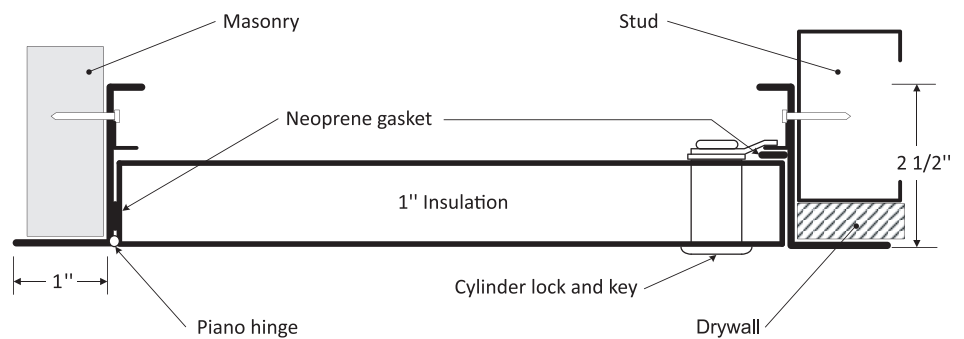

Table of standard sizes

[other sizes available upon request]

DOOR SIZE - W x H INCHES (MM)	NUMBER OF LOCKS	SHIPPING WEIGHT	
		LBS	KG
8 x 8 (203 x 203)	1	2	0.9
12 x 12 (304 x 304)	1	3	1.4
16 x 16 (406 x 406)	1	6	2.7
18 x 18 (457 x 457)	1	7	3.2
24 x 24 (609 x 609)	1	13	5.9
24 x 36 (609 x 914)	2	17	7.7
36 x 36 (914 x 914)	2	21	9.5

Rough wall opening = door size + 1/4" or + 6mm

**Your odd sizes:
Made in 5 days**

The **DRD** is mainly designed to allow passage **between attic sections** while **preventing back drafts** from one to the other. Although not rated, it is self closing and self latching and can be opened from both sides.



DESCRIPTION

- Material:** 16 gauge cold rolled steel
- Hinge:** continuous piano hinge
- Lock / latch:** self latching tool-key operated latch and/or ring operated latch, both included
- Inside panel release:** standard on all doors over 12" x 12"
- Automatic panel closer:** standard on all doors
- Finish:** high quality white powder coat primer
- Packaging:** individually wrapped, 1 per box

POPULAR OPTIONS [see p. 26-29 for complete list of options]

- Material:** stainless steel 304 #4 (brushed finish)
- Lock / latch:** key operated cylinder cam latch, handle operated slam latch, mortise preparation for cylinder (cylinder optional), mortise deadbolt lock
- Gasketing:** neoprene gasket

LEED ready: This product contributes to LEED® credits. Visit www.cendrex.com for more information.

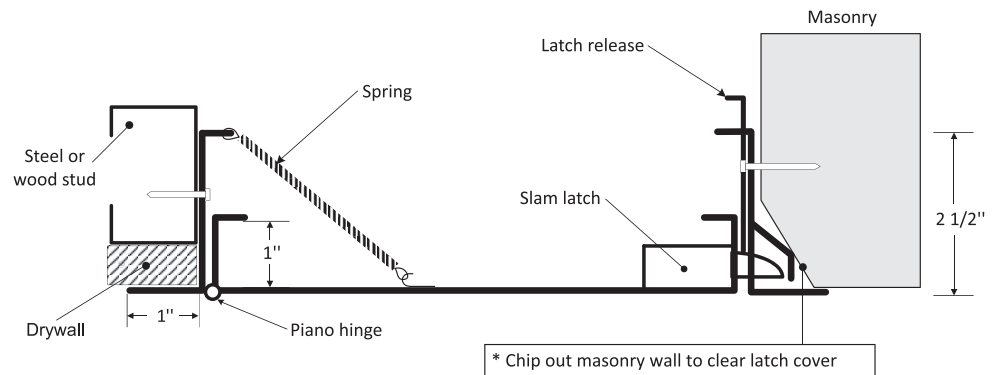

Table of standard sizes

[other sizes available upon request]

DOOR SIZE - W x H INCHES (MM)	NUMBER OF LOCKS	SHIPPING WEIGHT	
		LBS	KG
22 x 30 (558 x 762)	1	22	10
22 x 36 (558 x 914)	2	28	12.2
24 x 36 (609 x 914)	2	29	14.1
24 x 48 (609 x 914)	2	37	16.8
24 x 60 (609 x 1524)	2	44	20
30 x 30 (762 x 762)	1	30	13.6
36 x 36 (914 x 914)	2	39	17.7
36 x 48 (914 x 1219)	2	49	22.2

Rough wall opening = door size + 1/4" or + 6mm

**Your odd sizes:
Made in 5 days**

SFM

SURFACE MOUNTED ACCESS DOOR

The SFM does **not** require any framing or cutting of inner wall obstructions. It is designed to sit directly on the wall and can be installed easily with fasteners on the 4 corners.



Your odd sizes:
Made in 5 days

Table of standard sizes

[other sizes available upon request]

DOOR SIZE - W x H INCHES (MM)	CLEAR INSIDE OPENING INCHES (MM)	NUMBER OF LOCKS	SHIPPING WEIGHT	
			LBS	KG
8 x 8 (203 x 203)	7 3/4 x 7 (197 x 178)	1	3	1.4
12 x 12 (304 x 304)	11 3/4 x 11 (298 x 279)	1	5	2.3
16 x 16 (406 x 406)	15 3/4 x 15 (400 x 381)	1	8	3.6
* 18 x 18 (457 x 457)	17 3/4 x 17 (451 x 432)	1	10	4.5
* 24 x 24 (609 x 609)	23 3/4 x 23 (603 x 584)	1	15	6.8

*Not recommended for ceilings

DESCRIPTION

- Material:** 16 gauge cold rolled steel
- Hinge:** continuous piano hinge
- Lock / latch:** screwdriver operated cam latch
- Finish:** high quality white powder coat primer
- Packaging:** individually wrapped, 1 per box

POPULAR OPTIONS

[see p. 26-29 for complete list of options]

- Material:** stainless steel 304 #4 (brushed finish)
- Lock / latch:** key operated cylinder cam latch, hex head cam latch, pinned hex head cam latch

LEED ready: This product contributes to LEED® credits.
Visit www.cendrex.com for more information.

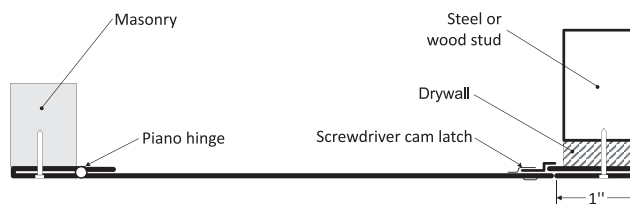

RPL

REMOVABLE PLASTIC ACCESS DOOR NON-RATED

The RPL is a **removable high impact ABS plastic access panel** with UV stabilizers. It can be used for access to plumbing, electrical and other types of wiring, computer cables and sprinkler systems. Its reversible frame allows for flush or surface mounting.



DESCRIPTION

- Material:** high impact ABS plastic with UV stabilizers
- Lock / latch:** snap friction catch
- Finish:** white textured finish
- Packaging :** individually wrapped, 1 per box
- Installation:** adhesive caulking recommended

Table of standard sizes

ACCESS DOOR CODE	DOOR SIZE (A" x B")	WALL OPENING (E" x F")	FRAME SIZE TO OUTER FLANGE (C" x D")	SHIPPING WEIGHT	
				LBS	KG
6 x 9	6 x 9	6 3/8 x 9 3/8	8 1/4 x 11 1/4	0.5	0.23
8 x 8	8 x 8	8 3/8 x 8 3/8	10 1/4 x 10 1/4	0.5	0.23
14 x 14	13 3/4 x 13 3/4	14 x 14	17 x 17	1.95	0.88
14 x 29	13 3/4 x 29	14 x 29 1/2	17 x 32 1/4	4.55	2

BTA-BTV

CABINETS / VALVE BOXES WITH HIDDEN FLANGE

Thanks to its **beveled door panel**, the **BTA** valve box is practical and aesthetically pleasing. It comes in various sizes and depths and can be pre-drilled to accept water pipes, gas pipes and conduits. The **BTV** model comes with a **Plexiglass window**.



BTA



BTV

DESCRIPTION

- Material:** 16 gauge cold rolled steel
- Hinge:** concealed, exclusive hinge design
- Lock / latch:** screwdriver operated cam latch
- Finish:** high quality white powder coat primer
- Packaging:** individually wrapped, 1 per box
- Depth:** 4" or 6"
- Window:** 1/8" Plexiglass (BTV only)

POPULAR OPTIONS [see p. 26-29 for complete list of options]

- Material:** stainless steel 304 #4 (brushed finish)
- Lock / latch:** cylinder lock and key, Allen head hex lock
- Style:** surface mount cabinet (style AHD)
- Depth:** various depths available
- Unassembled:** door frame separate from cabinet

LEED ready: This product contributes to LEED® credits.
Visit www.cendrex.com for more information.

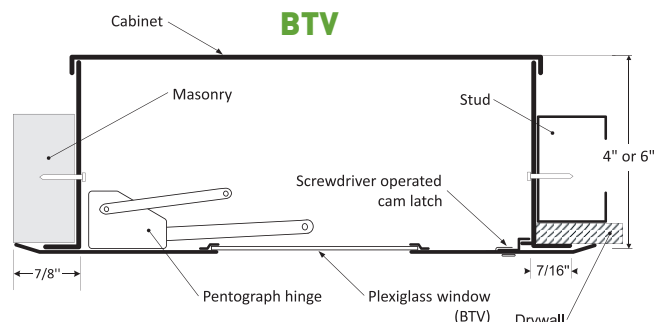
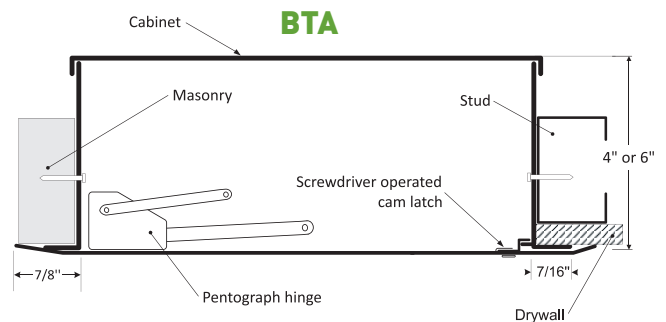

Table of standard sizes [other sizes available upon request]

DOOR SIZE - W x H INCHES (MM)	WINDOW SIZE FOR BTV (approx.)	NUMBER OF LOCKS
8 1/4 x 8 1/4 (209 x 209)	3 x 3 (76 x 76)	1
12 x 12 (304 x 304)	5 x 5 (127 x 127)	1
16 x 16 (406 x 406)	8 x 8 (203 x 203)	1
Rough wall opening = door size + 1/2" or + 12.7mm		

Your odd sizes:
Made in record time

The **MDS** is a **non-rated flush door built for extra reinforcement**. It is constructed with thicker steel, a **continuous piano hinge** and a key operated cylinder cam latch. It is designed to ensure medium security wherever it may be required.



DESCRIPTION

- Material:** 14 gauge galvalneal steel
- Hinge:** continuous piano type
- Lock / latch:** key operated cylinder cam latch
- Finish:** high quality white powder coat primer
- Packaging:** individually wrapped, 1 per box

POPULAR OPTIONS

[see p. 26-29 for complete list of options]

- Material:** stainless steel 304 #4 (brushed finish)
- Lock / latch:** mortise preparation for cylinder (cylinder optional), pinned hex head cam latch, 4" key handle operated cam latch, mortise deadbolt lock

LEED ready: This product contributes to LEED® credits. Visit www.cendrex.com for more information.

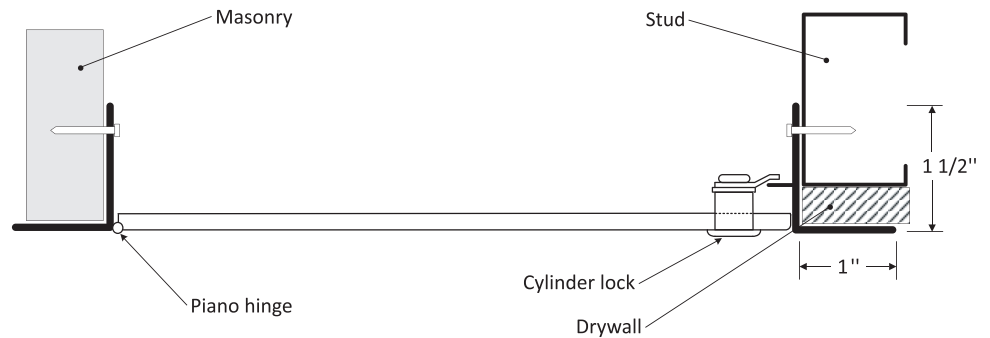

Table of standard sizes

[other sizes available upon request]

DOOR SIZE - W x H INCHES (MM)	NUMBER OF LOCKS	SHIPPING WEIGHT	
		LBS	KG
12 x 12 (304 x 304)	1	6	2.7
16 x 16 (406 x 406)	1	7	3.2
18 x 18 (457 x 457)	1	11	5
24 x 24 (609 x 609)	1	19	8.6
24 x 30 (609 x 762)	2	24	10.9
24 x 36 (609 x 914)	2	27	12.2
36 x 36 (914 x 914)	2	41	18.6

Rough wall opening = door size + 1/4" or + 6mm



**Your odd sizes:
Made in 5 days**

The **PHS** is designed to be used in situations **where security is of the utmost importance**. It is manufactured with detention grade materials and can be prepped for all types of dead locks.



Shown with optional mortise deadbolt lock and cylinder

DESCRIPTION

- Material:** 10 gauge cold rolled steel plate
2" x 2" x 3/16" thick angle frame
- Hinge:** 3" x 3" (13 Ga Steel) heavy duty butt hinges
13 gauge cold rolled steel
- Lock / latch:** as per customer's request (see options)
- Finish:** high quality white powder coat primer
- Packaging:** individually wrapped, 1 per box

POPULAR OPTIONS [see p. 26-29 for complete list of options]

- Lock / latch:** mortise preparation (cylinder optional),
mortise deadbolt lock,
mortise preparation for detention lock

LEED ready: This product contributes to LEED® credits.
Visit www.cendrex.com for more information.

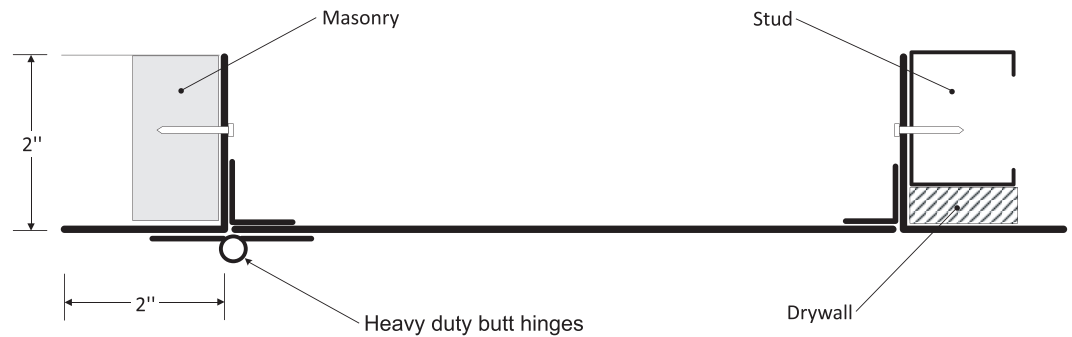

Table of standard sizes

[other sizes available upon request]

DOOR SIZE - W x H INCHES (MM)	SHIPPING WEIGHT	
	LBS	KG
12 x 12 (304 x 304)	22	10
16 x 16 (406 x 406)	30	13.6
18 x 18 (457 x 457)	34	15.4
24 x 24 (609 x 609)	49	22.2
24 x 30 (609 x 762)	57	25.9
24 x 36 (609 x 914)	65	29.5
36 x 36 (914 x 914)	86	39

Rough wall opening = door size + 1/4" or + 6mm

**Your odd sizes:
Made in 5 days**

Shown with optional mortise deadbolt lock and cylinder



The **PPA** is built for interior use to provide a **reliable and secure access** between building floors. Its sturdy 1/4" thick diamond or smooth finish aluminum plate and 1/4" thick aluminum frame construction make it the ideal solution for either existing cement floors or poured-in-place concrete.

DESCRIPTION

Material: DOOR: 1/4" aluminum diamond plate
FRAME: 2" x 2" x 1/4" aluminum angle

Hinge: heavy duty aluminum continuous piano hinge (0.080")

Lock / latch: recessed handle operated cam latch

POPULAR OPTIONS

[see p. 26-29 for complete list of options]

Lock / latch: Key operated recessed handle cam Latch

Recess: recessed floor hatch - see PPA-RE model
1/8", 3/16", 1/4", 3/8", 1/2", 5/8",
11/16" and 3/4"

Caution: The PPA floor hatch is designed to support a live load of 300 pounds/sq.foot and includes a hold open arm to keep the door in an open position.

LEED ready: This product contributes to LEED® credits. Visit www.cendrex.com for more information.

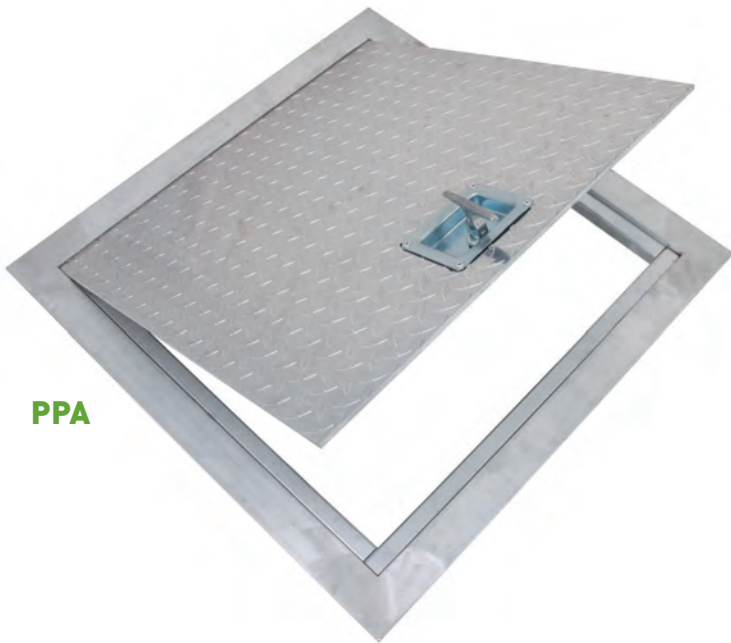

PPA



PPA-RE

RECESSED FLOOR HATCH

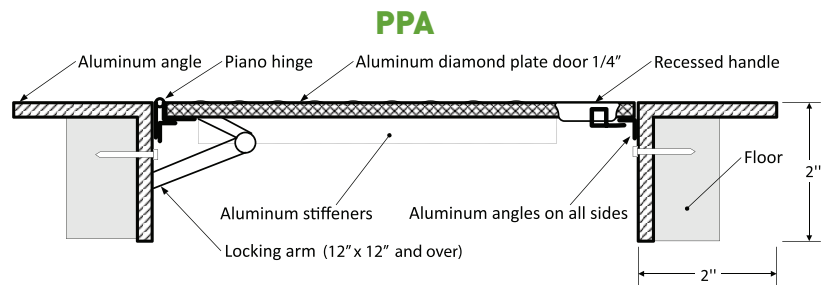

PPA

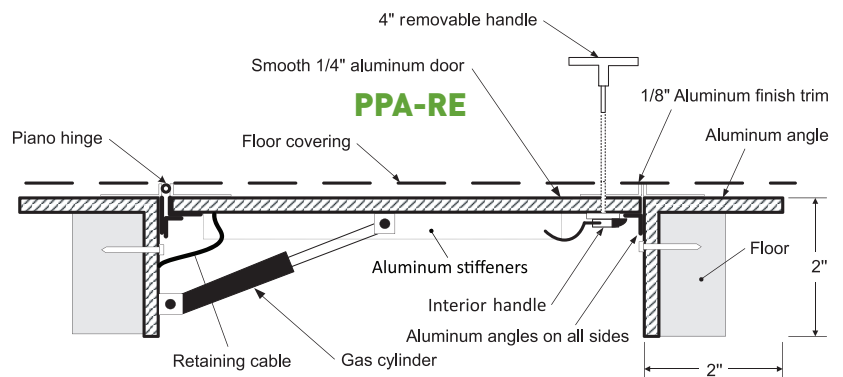

PPA-RE

Table of standard sizes

[other sizes available upon request]

HATCH SIZE - W x H INCHES (MM)	NUMBER OF LOCKS	SHIPPING WEIGHT	
		LBS	KG
24 x 24 (609 x 609)	1	35	15.9
24 x 36 (609 x 914)	1	44	20

Rough floor opening = door size + 1/2" or + 13mm

**Your odd sizes:
Made in 10 days**

The **TRH** roof hatch, made of galvanized steel, is designed to offer convenient access to building roof tops. It is equipped with gas cylinders providing an effortless opening of the door panel. Its heavy duty design and insulation ensure long life and low maintenance.



DESCRIPTION

- Cover:** 14 gauge galvanized steel with 1" fiberglass insulation
- Curb:** 14 gauge galvanized steel with 1" fiber board insulation
- Seal:** "D" - foam adhesive gasket provides a flush and tight fit
- Components:** 2 gas cylinders, retaining bar handles
- Finish:** high quality white powder coat primer
- LEED®:** When painted white, the TRH could contribute to meeting SSc7.2 (Heat Island Effect) requirements for highly reflective roofing materials.

POPULAR OPTIONS [see p. 26-29 for complete list of options]

Material: aluminum

LEED ready: This product contributes to LEED® credits. Visit www.cendrex.com for more information.

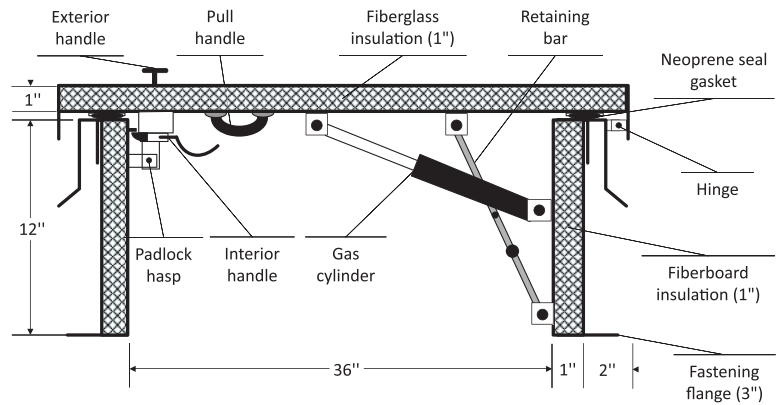

Table of standard sizes

[other sizes available upon request]

HATCH SIZE - W x H INCHES (MM)	EXTERIOR SIZE - W x H INCHES (MM)	NUMBER OF LOCKS	SHIPPING WEIGHT	
			LBS	KG
36 x 30 (914 x 762)	42 x 36 (1067 x 914)	1	178	81
36 x 36 (914 x 914)	42 x 42 (1067 x 1067)	1	188	85

Roof opening = size of roof hatch

Your odd sizes:
Made in 10 days

ODD SIZE DOORS MANUFACTURED IN 5 BUSINESS DAYS

USE ODD SIZE DOORS:

- Where there are wall or ceiling obstructions
- To gain access to special equipment
- For confined spaces
- For poorly framed walls and ceilings
- For existing openings



Odd size **AHD**

**ANY DOOR
ANY SIZE**



Odd size **CTR**



Odd size **LHD**

**Your odd sizes:
Made in 5 days**

CUSTOM DOORS MANUFACTURED IN 10 BUSINESS DAYS

Call us and together we will design the ideal doors for your special applications.

CENDREX'S R&D DEPARTMENT

When creating your custom doors you will have access to:

- A team of experienced engineers to help you design the product that best suits your needs
- A technical drawing team using state of the art software to provide you with accurate and precise drawings and prototypes
- A quick response and the shortest lead time in the industry to meet your tight deadlines

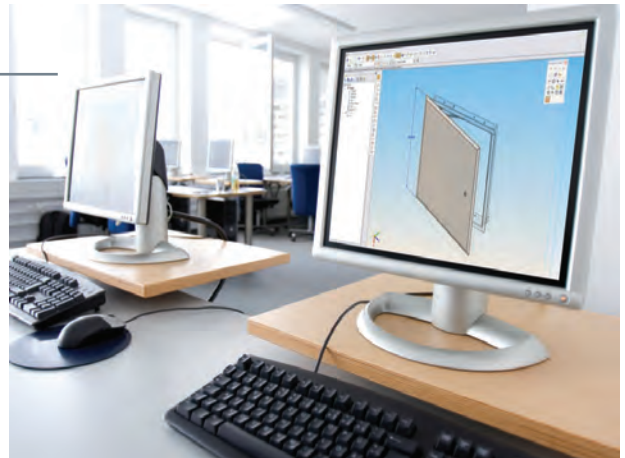

EXAMPLES OF CUSTOM DOORS:

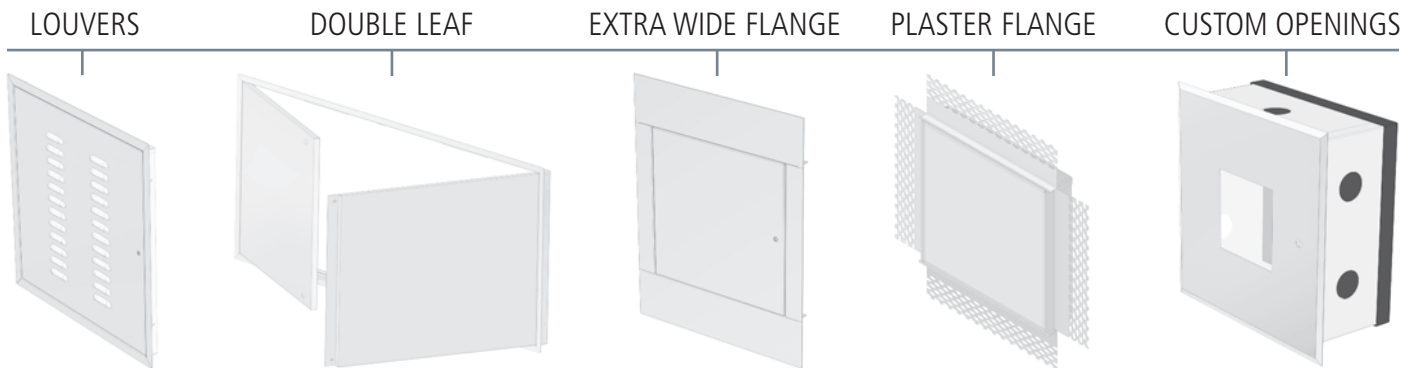

PROCESS FOR CREATING YOUR CUSTOM DOORS:

- 1** Define your needs with the help of CENDREX
- 2** Approve drawings created by CENDREX based on those needs
- 3** Order and we will manufacture your custom doors in 10 days

Custom doors:
Made in 10 days

Options are available for ALL ACCESS PRODUCTS to better accommodate your needs and to provide specification compliance. In this section (p. 26-29) you will find the list of options, their codes and the complete chart.

- **OPTIONS:** Divided into 4 sections: LOCKS AND LATCHES, HANDLES, MATERIALS AND OTHER OPTIONS.
- **OPTIONS CODES:** Codes are in blue for easy identification and ordering purposes.
- **OPTIONS CHART:** Designed to inform you of the various options available for each product.

Please visit our website at www.cendrex.com for up-to-date options information.

MEDIUM AND HIGH SECURITY LOCKS AND LATCHES:



85 - MORTISE SLAM LATCH

The panel will accept cylinders 1 5/32" in diameter from most lock manufacturers (Best, Ilco, Corbin, etc). Enables the slam latch to operate with matching project hardware.
(CYLINDER OPTIONAL - 85C)



15 - MORTISE CAM LATCH

The panel will accept cylinders 1 5/32" in diameter from most lock manufacturers (Best, Ilco, Corbin, etc).
(CYLINDER OPTIONAL - 15C)



C - CYLINDER FOR DEADBOLT LOCK OR MORTISE

Keyed different is standard.
Keyed alike is optional. - CKA

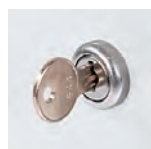

10 - KEY OPERATED CYLINDER CAM LATCH

Recommended for security access or where locks are required for controlled access.
Keyed alike is standard.
Keyed different is optional. - 10KD



40 - MORTISE DEADBOLT LOCK

Recommended for high security applications. The panel will accept cylinders 1 5/32" in diameter from most lock manufacturers (Best, Ilco, Corbin, etc).
(CYLINDER OPTIONAL - 40C)

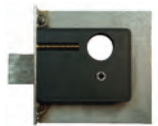

99 - INSIDE RELEASE THUMBTURN FOR MORTISE DEADBOLT LOCK

Allows the door to be opened from the inside of the panel. Serves as a safety mechanism.
(Available only with - 40)



45 - MORTISE PREPARATION FOR DETENTION DEADBOLT LOCK



46 - DETENTION DEADBOLT LOCK



47 - DETENTION DEADBOLT KEY



90 - PINNED HEX HEAD CAM LATCH

Recommended for more secure applications. Requires a special pinned allen key to open the access door. Key sold separately.

AK-90 - ALLEN KEY FOR PINNED HEX HEAD CAM LATCH

REGULAR LATCHES:



35 - SCREWDRIVER CAM LATCH

Standard on general purpose access doors. Available in cold rolled steel, stainless steel and galvaneal steel.

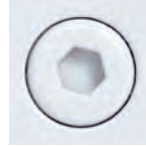

50 - HEX HEAD CAM LATCH

Requires a standard allen key to open the access door. Offers added security. Key sold separately.

AK-50 - ALLEN KEY



80 - RING/TOOL KEY OPERATED SLAM LATCH

Standard latching mechanism on all our fire rated models. It allows the door to shut by itself when attached with a spring.



55 - HEX HEAD SLAM LATCH

Requires a standard allen key to open the access door. Offers added security. Key sold separately.

AK-55 - ALLEN KEY



220 - SCREWDRIVER OPERATED CYLINDER CAM LATCH

Available for PAL and LHD models only.



30 - SLIDE LATCH

Allows the door to be opened using a simple sliding action.

OPTION ↓	MODEL →	GENERAL PURPOSE			FIRE RATED			RECESSED		SPECIALTY		CABINET VALVE BOX SECURITY			FLOOR HATCH	ROOF HATCH	
		CTA	CTR	AHD	PFI	PFU	PFN	AHA	LHD	PAL	DRD	SFM	BTA	MDS	PHS	PPA	TRH
C	CYLINDER FOR DEADBOLT LOCK OR MORTISE		●	●	●		●		●	●	●		●	●	●		●
10	KEY OPERATED CYLINDER CAM LATCH		●	●	●		●	● ¹	●	std.	●	●	●	std.			
15	MORTISE CAM LATCH		●	●									●	●			
30	SLIDE LATCH		●	●									●				
35	SCREWDRIVER CAM LATCH	●	std.	std.								std.	std.	●			
40	MORTISE DEADBOLT LOCK		●	●	●		●		●	●	●		●	●	●		●
45	MORTISE PREPARATION FOR DETENTION LOCK														●		
46	DETENTION DEADBOLT LOCK														●		
50	HEX HEAD CAM LATCH		●	●				std.				●	●	●			
55	HEX HEAD SLAM LATCH		●	●	●	std.	●		●	●	●		●	●			
80	RING/TOOL KEY OPERATED SLAM LATCH		●	●	std.		std.		std.	●	std.		●	●			
85	MORTISE SLAM LATCH		●	●	●		●		●	●	●		●	●			
90	PINNED HEX HEAD CAM LATCH		●	●				●				●	●	●			
220	SCREWDRIVER OPERATED CYLINDER CAM LATCH								●	●							

● = Option available

std. = Standard feature

1 - Maximum recess of 13/16"

OPTIONS

HANDLES, MATERIALS

HANDLES:



20
4" HANDLE OPERATED CAM LATCH



21
FIXED 4" HANDLE



22
4" HANDLE OPERATED SLAM LATCH



25
4" HANDLE AND KEY OPERATED CAM LATCH



26
L HANDLE
Allows the door to be opened from the inside of the panel.
Available only in combination with options 20, 22 or 25.



100K
KEY OPERATED RECESSED HANDLE CAM LATCH
Available for PPA model only.

OPTION ↓	MODEL →	GENERAL PURPOSE			FIRE RATED			RECESSED			SPECIALTY			CABINET VALVE BOX SECURITY			FLOOR HATCH ROOF HATCH	
		CTA	CTR	AHD	PFI	PFU	PFN	AHA	LHD	PAL	DRD	SFM	BTA BTV	MDS	PHS	PPA	TRH	
20	4" HANDLE OPERATED CAM LATCH		●	●				● ¹	●	●	●	●	●	●				
21	FIXED 4" HANDLE		●	●	●		●	● ¹	●	●	●	●	●	●	●		std.	
22	4" HANDLE OPERATED SLAM LATCH		●	●	●		●		●	●	●		●	●			std.	
25	4" KEY HANDLE OPERATED CAM LATCH		●	●				● ¹	●	●	●	●	●	●	●			
26	L HANDLE		● ²	● ²			● ⁴		● ²	● ²	● ²			● ²				
100K	KEY RECESSED HANDLE CAM LATCH															● ³		

1 - Provided, not installed. 2 - Available only in combination with options 20, 22 or 25.
3 - Not available for PPA recessed model. 4 - Available only in combination with option 22.

MATERIALS:

GALVANNEAL STEEL (SATIN COATED) - GS - ALUMINUM - AL

STAINLESS STEEL - SS - COLD ROLLED STEEL - CR

OPTION ↓	MODEL →	CTA	CTR	AHD	PFI	PFU	PFN	AHA	LHD	PAL	DRD	SFM	BTA BTV	MDS	PHS	PPA	TRH
GS	GALVANNEAL STEEL		●	●	std. door	std. door	●	●	●		●	●	●	std.			std.
AL	ALUMINUM									std.						std.	●
SS	STAINLESS STEEL		●	●	●	●	●	●	●	●	●	●	●	●			
CR	COLD ROLLED STEEL	std. door	std.	std.	std. frame	std. frame	std.	std.	std.	●	std.	std.	std.	●	std.		

OTHER OPTIONS:



60 - GASKET

Recommended to provide weather resistance and to reduce airflow between the panel and frame.



110 - CONTINUOUS PIANO HINGE

Standard on our fire rated doors and usually recommended for use on larger doors. It provides specification compliance when required. Available in cold rolled steel or stainless steel.



140 - LOUVERED DOORS

Allows ventilation for special applications.



160 - HOLDING CABLE



180 - DOUBLE LEAF

Recommended for access to large openings.



240 - MASONRY ANCHORS

Recommended to secure the door in place when installed in masonry.



GYP - DRYWALL FLANGE

Only the door will be visible when drywall compound is applied to the corner bead flange.



PLY - PLASTER FLANGE

The 2 3/4" lath flange will disappear when covered with plaster, leaving only the door panel visible.



OTHER OPTIONS AVAILABLE UPON REQUEST

OPTION ↓	MODEL →	GENERAL PURPOSE			FIRE RATED			RECESSED SPECIALTY			CABINET VALVE BOX SECURITY			FLOOR HATCH ROOF HATCH			
		CTA	CTR	AHD	PFI	PFU	PFN	AHA	LHD	PAL	DRD	SFM	BTA BTV	MDS	PHS	PPA	TRH
60	GASKET		●	●	●		●	●	●	std.	●		●	●	●	●	std.
110	CONTINUOUS PIANO HINGE			opt. ≤24" std. >24"	std.	std.	std.	std.	std.	std.	std.	std.	● ¹	std.		std.	
140	LOUVERED DOORS		●	●					●		●	●	●	●			
160	HOLDING CABLE		●	●					●								
180	DOUBLE LEAF			●					●	●	●		● ²	●			
240	MASONRY ANCHORS		●	●	●		●	●	●	●	●		●	●	●		
GYP	DRYWALL FLANGE			●	●		●	●	●		●						
PLY	PLASTER FLANGE			●	●		●	●	●		●						

1 - Standard on surface mounted cabinet (style AHD) over 24" in height or width.

2 - Surface mounted only.



To Whom it May Concern,

As specialists in LEED® certification, we at Vertima in Canada and YRG sustainability in the U.S.A. hereby confirm that the CENDREX “LEED ready Program”, as communicated to various stakeholders including architects, engineers, distributors, and contractors, has been prepared and documented in collaboration with our firms.

CENDREX access doors have been analyzed in accordance with the following LEED® Rating Systems:
LEED® U.S. (LEED®-NC, CS, CI and Schools) and LEED® Canada (LEED® Canada-NC, CS and CI).

The CENDREX “LEED ready Program” includes the following documents:

- **LEED® Overview**
A document describing the role of CENDREX products in obtaining LEED® credits, a description of the various LEED® Rating Systems, and the efforts put forth by CENDREX to reduce its environmental footprint.
- **LEED® Data Sheets**
LEED® data sheets for each individual CENDREX access door, including its contribution to LEED® requirements and an analysis for each LEED® Rating System.
- **LEED® Compliance Letters**
Documents required for the execution of LEED® projects. CENDREX will provide these duly completed letters, upon request, in order to facilitate your LEED® certification process.

CENDREX also retains the services of Vertima and YRG to validate and document any changes to existing systems as established by the **Canada Green Building Council** and the **U.S. Green Building Council**.



As experts in LEED® certification, we will gladly discuss the documentation process and rigorous training that CENDREX followed in order to ensure that the information disclosed to all professional parties remains entirely accurate at all times.

Sincerely,

Josée Lupien - LEED® AP, BD+C
President
Vertima inc.
joseelupien@vertima.ca
www.vertima.ca

Lauren Yarmuth - LEED® AP, BD+C
Principal
YRG sustainability
lyarmuth@yrgsustainability.com
www.yrgsustainability.com



Visit www.cendrex.com for a complete and up-to-date description of the CENDREX LEED® ready Program.

LEED ready



CENDREX Access Doors: Sustainable products that can help with your LEED® Certification!

Using CENDREX Access Doors directly contributes to a project's ability to achieve LEED® U.S. certification under the LEED-NC, CS, CI and Schools Rating Systems and LEED® Canada certification under the LEED® Canada-NC, CS and CI Rating Systems.

CENDREX Access Doors directly support the following valuable LEED® credits:

SS 7.2: Heat Island Effect – Roof (LEED-CI (U.S.) - SS 1, Option 2, Path 5)

CENDREX roof hatches are available in a white painted finish which may contribute to meeting SS 7.2 requirements for highly reflective roofing materials. Confirmation of the SRI value could be provided in the LEED® certification process.

EAp2: Minimum Energy Performance and EA 1: Optimize Energy Performance

Insulated CENDREX Access Doors and roof hatches can contribute to a high-performance building envelope and associated energy use reduction. CENDREX Access Doors for exterior applications are available with various R-values. These insulated doors and hatches are designed to support, rather than detract from the overall R-value of the building envelope assembly, therefore contributing to the achievement of points under EA 1.

MR 4: Recycled Content

All CENDREX access doors have significant amounts of pre- and post-consumer recycled content. In fact, our access doors contain from **0%** to **19.65%** pre-consumer recycled content and from **17.88%** to **70.53%** post-consumer recycled content. Therefore, CENDREX doors can help meet the recycled-content requirements in projects looking to earn MR4 credit. The percentages were calculated as the ratio of component weight to assembled-door weight.

MR 5: Regional Materials

CENDREX Access Doors may contribute towards Regional Materials credits, depending on the location of the project site and the CENDREX products selected. The product contribution for each component will be calculated as their percentage by weight of the total product. The final manufacturing site is in Montreal, Qc, Canada H1E 6N6.

U.S.A. – (Requirements: 10 / 20%)

CENDREX provides a potential contribution to MR 5 for projects in most parts of the New England and Mid-Atlantic Regions of the U.S. For LEED-NC, CS, Schools and LEED-CI, Option 2, only those components of the product which are both extracted AND manufactured within 500 miles of the project site will be eligible for contribution.

Canada – (Requirements: 20 / 30%)

Most of the CENDREX components extraction sites are located less than 800 Km of the final manufacturing site. (e.g.: Steel extraction comes from Hamilton, Ontario L8N 3J5). In Canada the extraction is calculated from the location of the extraction site to the final manufacturing site.

IEQ 3.2: Construction Indoor Air Quality Management Plan – Before Occupancy, OPTION 2: Air Testing

CENDREX Access Doors are pre-finished off-site with Low- and No-VOC powder coatings. This can help projects meet the stringent Air Quality testing requirements of IEQ 3.2.

IEQ 4.2: Low-Emitting Materials: Paints and Coatings

CENDREX products are pre-finished off-site. Because this credit only applies to paints and coatings applied on site, CENDREX products do not contribute to IEQ 4.2: Low-Emitting Materials – Paints and Coatings. However, CENDREX products are finished with Low and No-VOC powder coatings, which are beneficial to indoor air quality.

CENDREX has developed specific tools and resources to better support the construction industry. All CENDREX documents required for LEED® certification are now available. They have been produced by LEED® certification specialists Vertima in Canada and YRG sustainability in the U.S.A., to provide you with comprehensive, reliable information.

All products have their own LEED® Data Sheet to facilitate your LEED® certification process. CENDREX will also provide duly completed LEED® Compliance Letters upon request.

You can obtain this up-to-date information in more detail on CENDREX'S website at www.cendrex.com





THE CENDREX ADVANTAGE:

CENDREX DESIGNS AND MANUFACTURES HIGH QUALITY STANDARD AND NON-STANDARD ACCESS DOORS, ROOF HATCHES, FLOOR HATCHES AND CABINETS / VALVE BOXES.



VISIT OUR WEBSITE

➤ **LEED** ready

CENDREX products contribute to obtaining LEED® credits.

All LEED® documents are developed in association with the foremost LEED® certification specialists, YRG in the U.S.A. and Vertima in Canada, to provide you with the most reliable and up-to-date information.

➤ **CTA:** REVOLUTIONARY ADJUSTABLE ACCESS DOOR

➤ **CTR:** HIDDEN FLANGE DOOR
“No need to mud or plaster”

➤ **ODD SIZE DOORS** MADE IN 5 DAYS

➤ **CUSTOM DOORS** MADE IN 10 DAYS



WAREHOUSES



info@cendrex.com

Tel.: 1 800 479-1489

Fax: 1 800 297-1489

www.cendrex.com

